

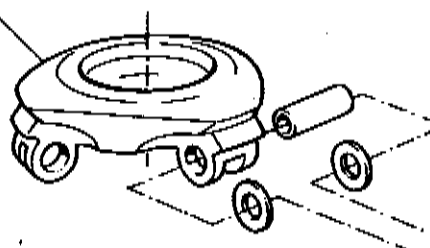

D1338.16

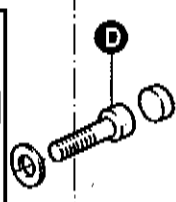

D1338.140

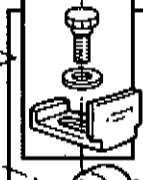

E



D1338.28

D1338.26

B

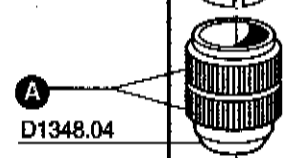

A

D1348.04



E

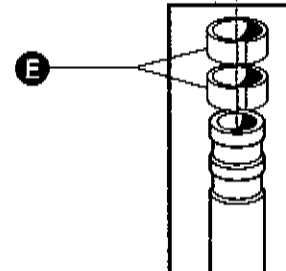

D1338.27

B



A

D1228.04

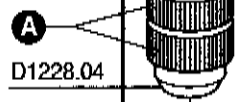



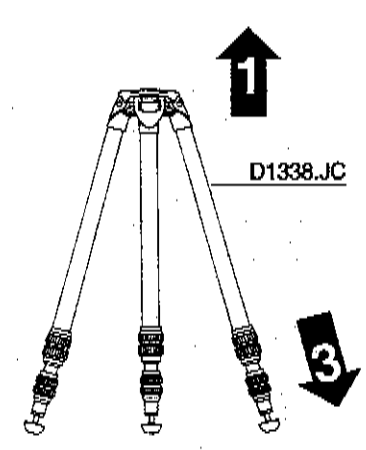

# MOUNTAINEER

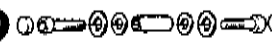

# G1338

### KITS

- A**  D1338.JB (complete tripod)
- B**  D340.JS (complete tripod)
- D**  D1338.FJ (one leg)
- E**  D340.JG (complete tripod)