

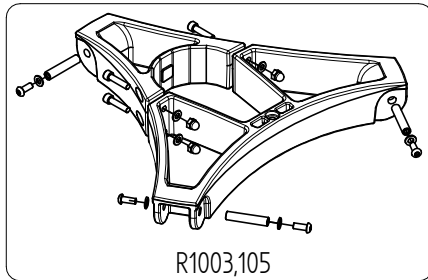

PROFESSIONAL CINE EQUIPMENT

ART. B7057BASE
ART. B7057FFBASE

For serial number
from XXXXXX



R1003,105

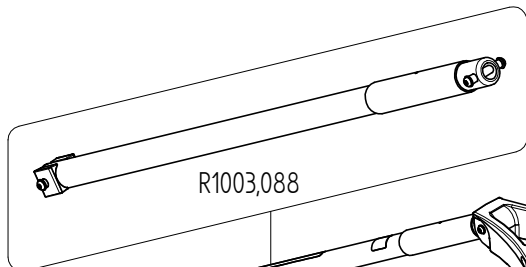

R1003,088

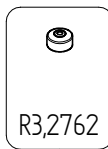

R3,2762

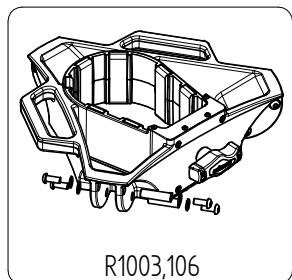
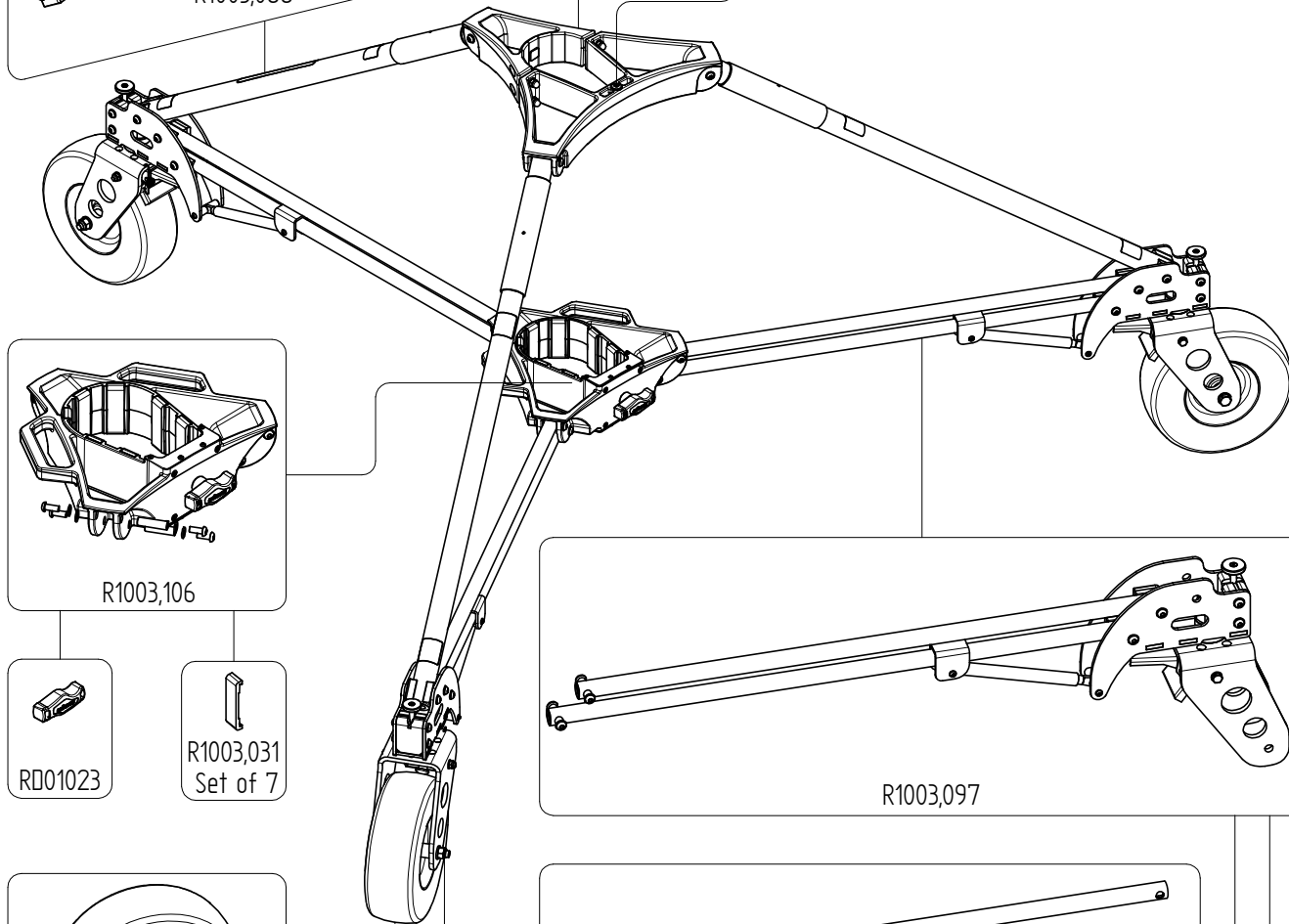

R1003,106



RD01023

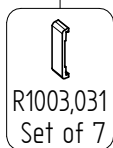

R1003,031
Set of 7

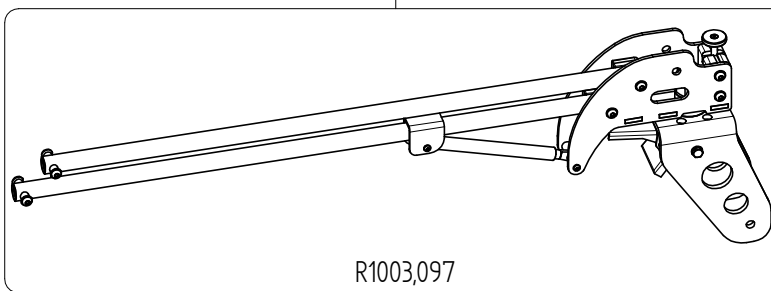

R1003,097

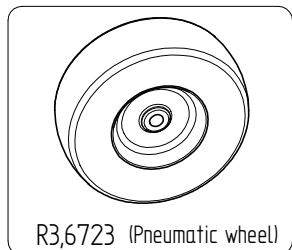

R3,6723 (Pneumatic wheel)

R3,7250 For B7057FF (foam fill wheel)

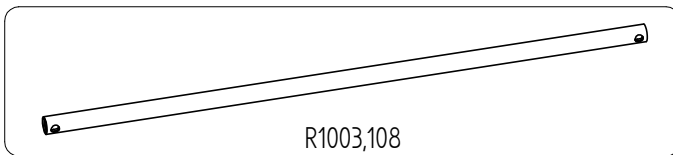

R1003,108

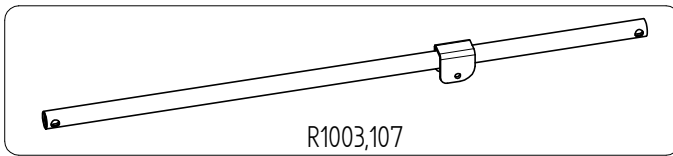

R1003,107

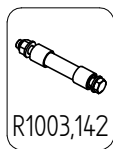

R1003,142

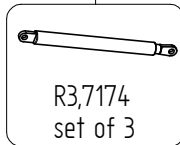

R3,7174
set of 3

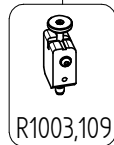

R1003,109



RB90003



R032,05AV
Set of 5