

# Manfrotto nord

ART.

695

For serial number  
from A0011106

2004-10-22

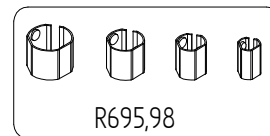
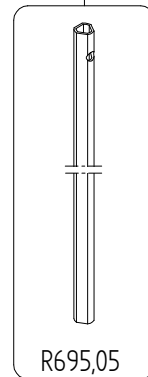
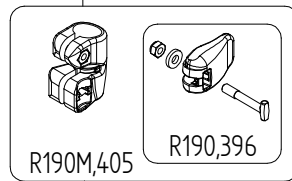
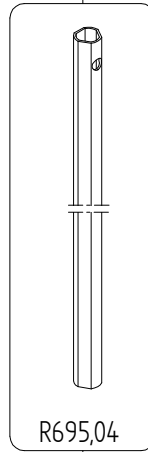
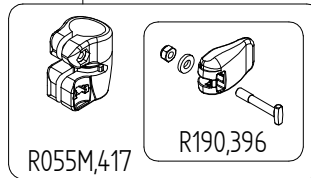
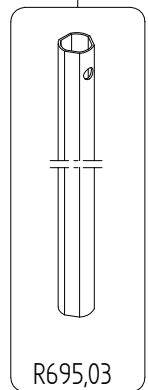
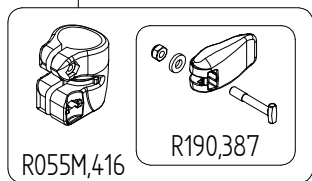
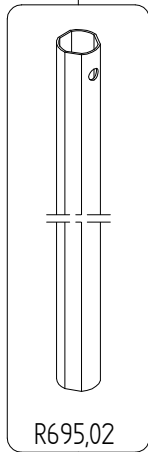
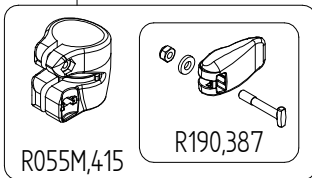
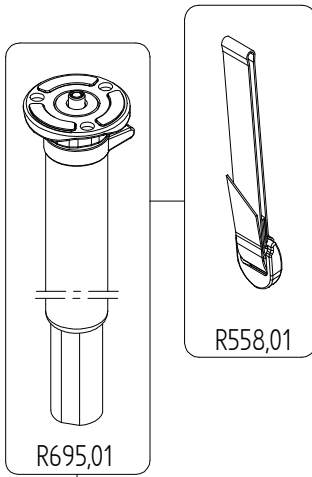

TO BE MOUNTED  
ON TUBES

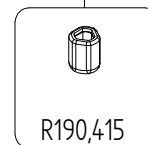

TO BE MOUNTED  
ON CLAMPING-COLLARS

