

R492,16
Set of 5

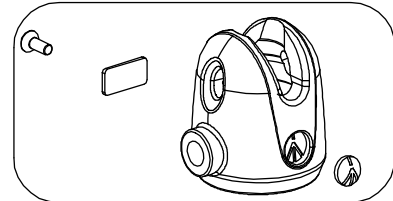

R492,11

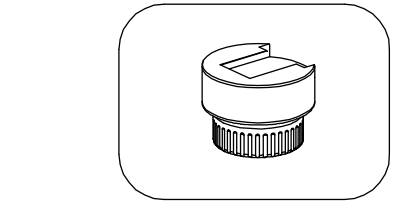
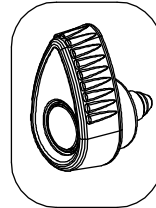
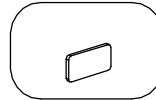
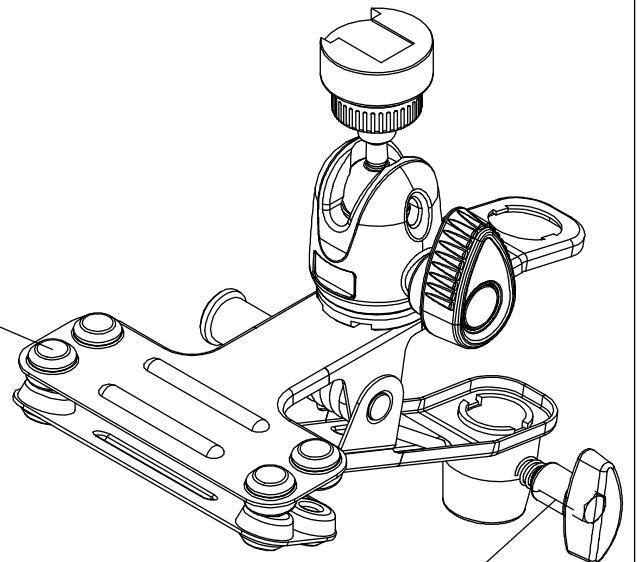
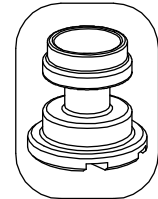
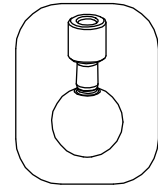

INNER BOX
RI,038,01
Set of 12

