

2005-09-30

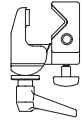
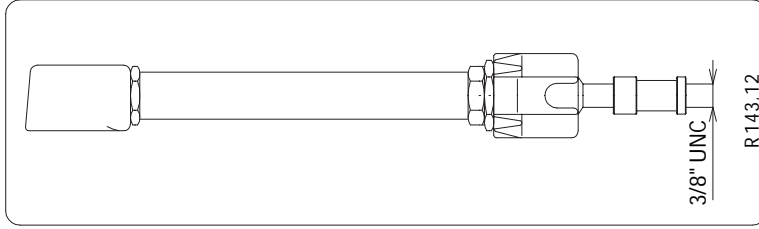
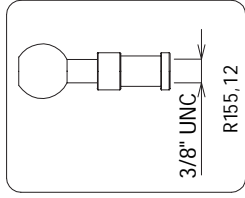
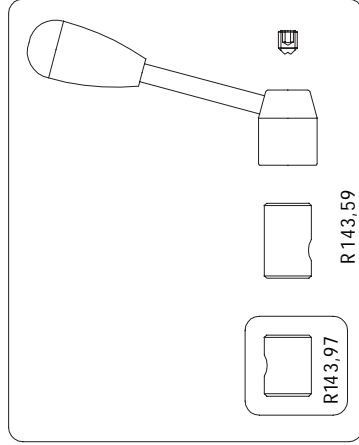
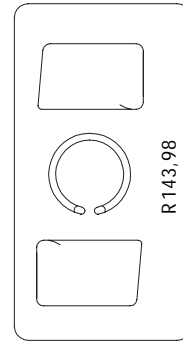
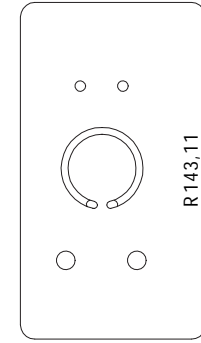
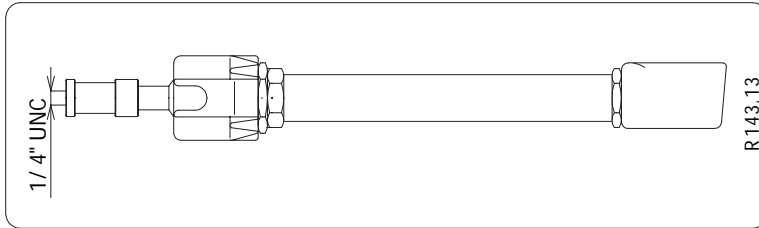
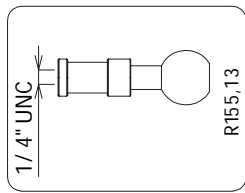
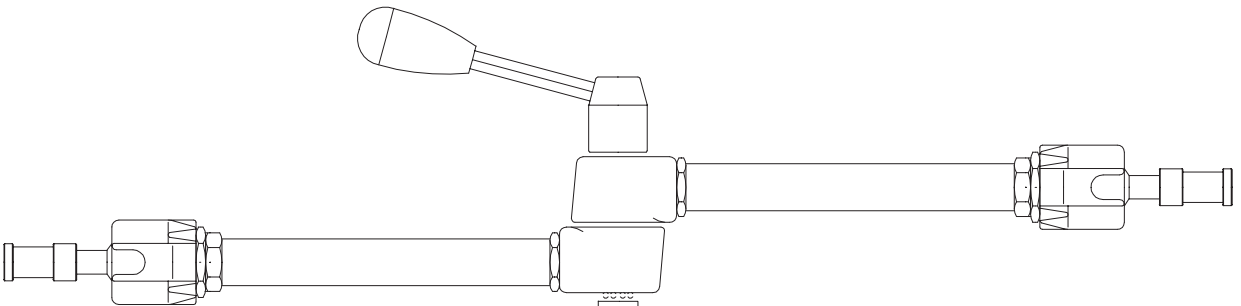

FOR SUPER CLAMP SPARE LIST SEE DRAWING: ART.035