

2005-09-30

3/8" UNC

1/4" UNC

ART. 015

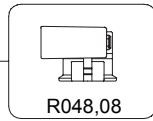
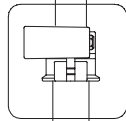

R053,36B

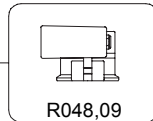
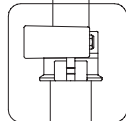

R053,37B

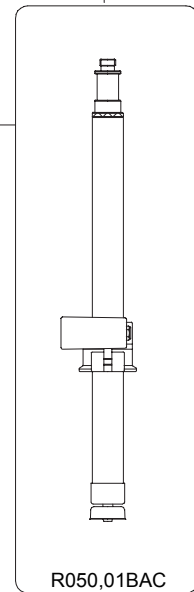
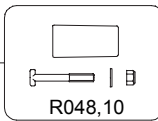
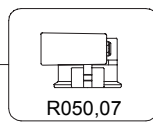
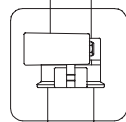

R050,01BAC

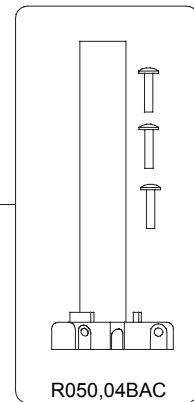

R050,04BAC

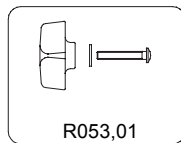

R053,01

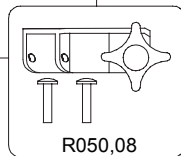
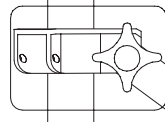

R050,08

R064,01

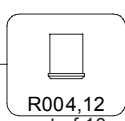
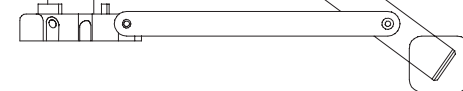

R004,12
set of 10

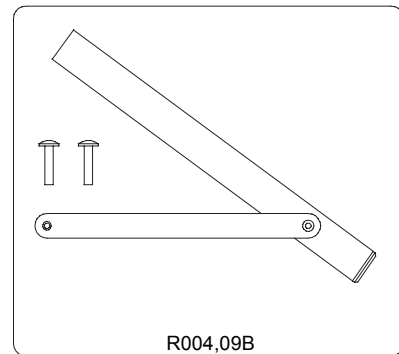

R004,09B