

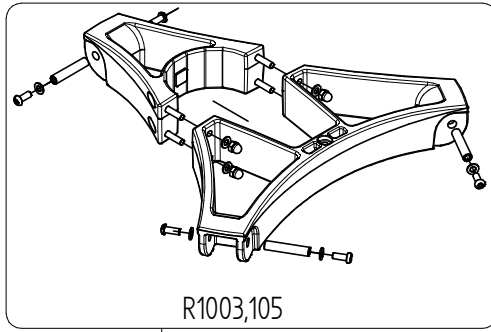

PROFESSIONAL CINE EQUIPMENT

ART. B7034BASE  
ART. B7034FFBASE

For serial number  
from XXXXXX



R1003,105

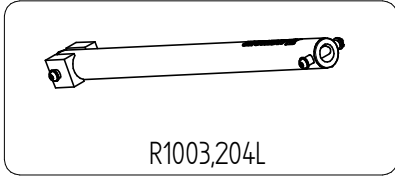

R1003,204L

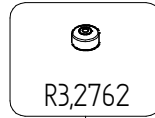

R3,2762

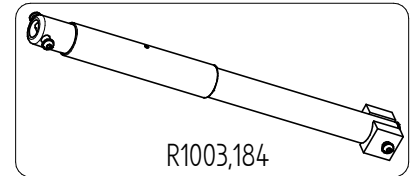

R1003,184

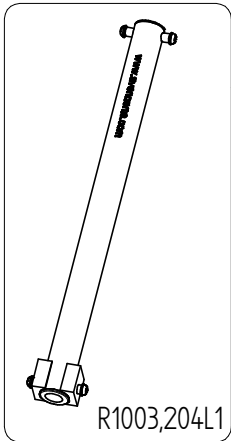
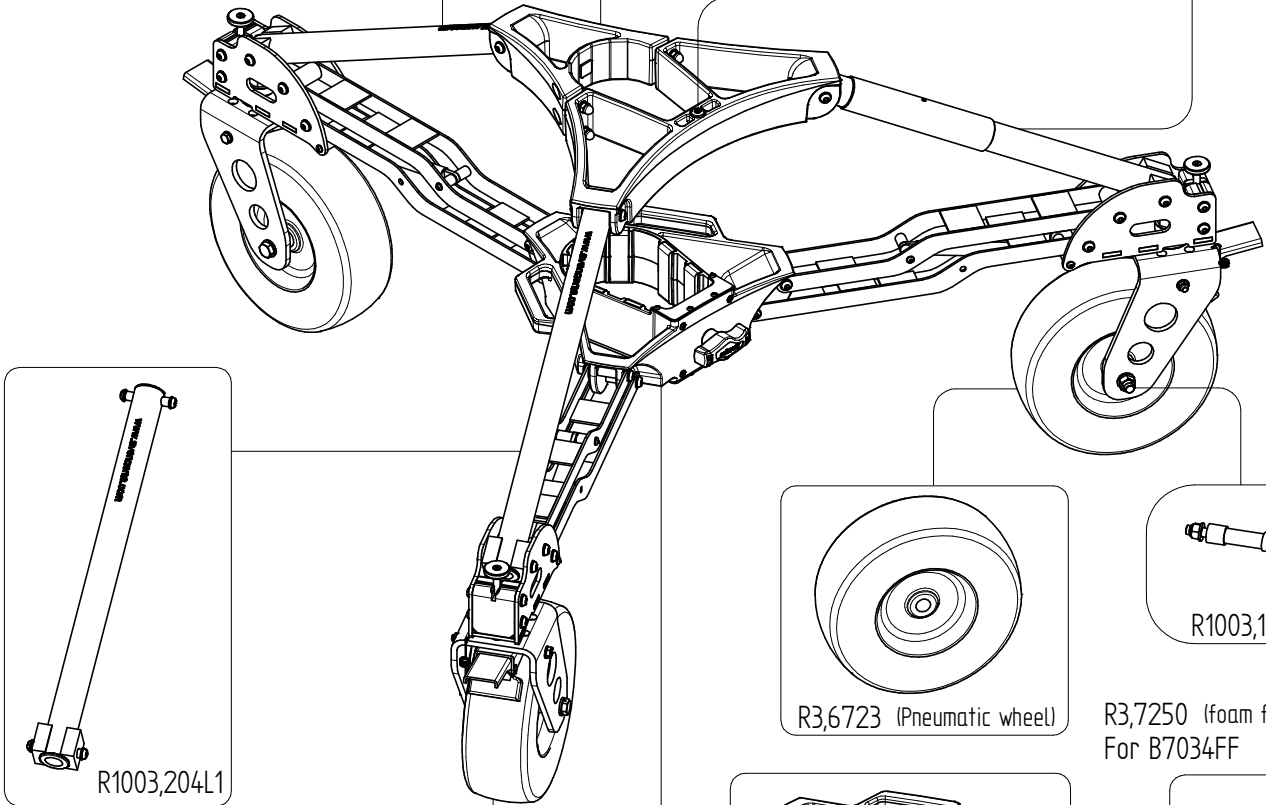

R1003,204L1

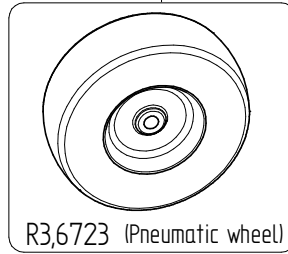

R3,6723 (Pneumatic wheel)

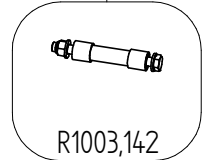

R1003,142

R3,7250 (foam fill wheel)  
For B7034FF

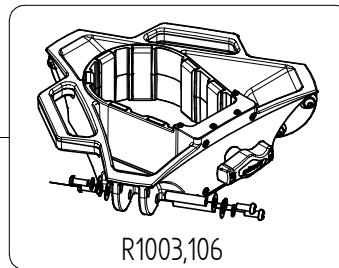

R1003,106

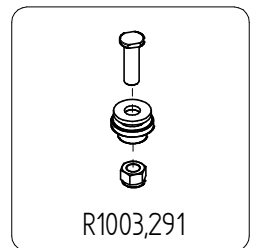

R1003,291

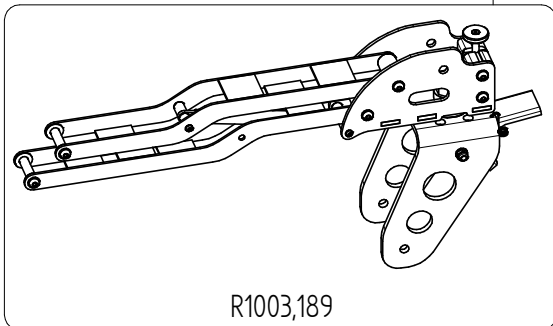

R1003,189

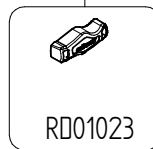

RD01023

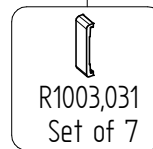

R1003,031  
Set of 7



R1003,188

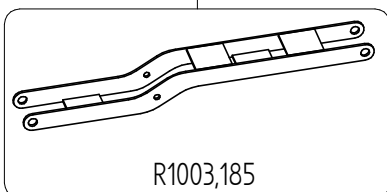

R1003,185



R3,7734  
Set of 3

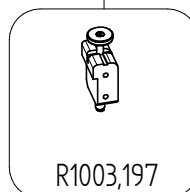

R1003,197



RB90003

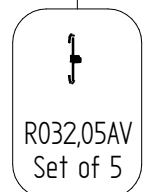

R032,05AV  
Set of 5